

14 Parts for TAC tools

Specifications of parts

■ Parts for TAC tools

● Screws	14-2
● Shims	14-7
● Clamps	14-13
● Clamp sets	14-15
● Levers	14-16
● Pins	14-17
● Chipbreaker pieces	14-18
● Springs	14-19
● Coolant supply attachments	14-20
● Pistons	14-20
● Nuts	14-20
● Coolant Pipe & Nozzle	14-20
● Sizing plates	14-21
● Washers	14-22
● Wrenches and drivers	14-22
● Locator	14-24
● Insert locking wedge	14-25
● Locator adjusting wedge	14-26
● Fine adjusting screw	14-26

Reference

■ Parts for former TAC tools

● Parts for former J-series toolholders	14-27
● Parts for former TAC mills	14-28
● Parts for former TAC drills	14-33

Screws

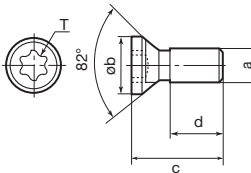
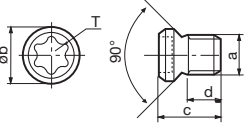
Shape	Part Cat. No.	Stock	Dimensions (mm)					Torque (N·m)	Applicable Tools			
			a	øb	c	d	T / f					
	CSTA-NO2	●	#2-56UNC	4	6	4	T8	1.3	TAC External Toolholders J series S-type TurnTec Turning A A-type MS-type TAC Internal Toolholders DoMiniBore TurnTec Turning A A-type Stream Jet Bar Stream Jet Bar mini S-type TAC Grooving & Parting Tools CGW-type SGT-type SNG-type			
	CSTA-NO2S	●			5	3						
	CSTA-NO2L	●			8	6						
	CSTA-NO3	●	#3-48UNC	4.3	7	4	T9	2.3				
	CSTA-NO5	●	#5-40UNC	5	8	5	T6	0.6				
	CSTA-1.6	●	M1.6x0.35	2.5	3.1	0.9						
	CSTA-4	●	M4x0.7	7	10	7.7	T15	3.5				
	CSTA-5	●	M5x0.8	7.2	15	11						
	CSTA-5S	●			12	8						
	CSTA-5SS	●			9.5	5.5						
	CSTA-5ST25	●			12	8	T25	5.0				
	CSPA-5	●			15	11	20IP	5.0				
	CSPA-5S	●			12	8						
	CSPA-5IP15	●			15	11	15IP	3.5				
CSPA-5SIP15	●	12			8	20IP	5.0					
CSPA-5IP20	●	15			11							
CSPA-5SIP30	●	12			8							
 <p>CSP-2L033 type shown</p>	CSP-2L033	●	M2x0.4	2.6	3.3	1.9	6IP	0.7	TAC Threading Tools ST-type Tooling Systems TAC Cartridge SP-type TAC Cartridge A-type TAC Boring Bar Tools "TOP-BORER" Tools TAC Mills DoRec TecSlot TAC Drills			
	CSTB-2	●			3.3	1.4	T6	0.7				
	CSTB-2L	●			5.2	3.3						
	CSTB-2L040	●	4	2.1	M2.2x0.45	3.5	T7	1.0				
	CSTB-2.2	●	6.1	3.5								
	CSTB-2.2L038	●	3.8	2.2								
	CSTB-2.2S	●	4.6	2								
	CSTB-2.2R	●	3.1	6.1						3.7		
	CSTB-2.5	●	M2.5x0.45	3.5	6	3.4	T8	1.3				
	CSTB-2.5L080	●			8	5.4						
	CSTB-2.5B	●			5.5	2.6						
	CSTB-2.5S	●			4.8	2.2						
	CSTB-3	●	M3x0.5	4.1	8	4.5	T9	2.3				
	CSTB-3L042	●			4.2	0.7						
	CSTB-3L050	●			5	2						
	CSTB-3S	●	6	2.5	M3.5x0.6	5.5	T15	3.5				
	CSTB-3.5ST	●	5.5	12.5						4		
	CSTB-3.5H	●	5.2	6.5						3.1		
	CSTB-3.5	●	5.5	8.4						4.3		
	CSTB-3.5T	●	6.5	10						5.5		
	CSTB-3.5TS	●	8.5	4						T20	5.0	
	CSTB-3.5D	●	4.7	8.4						4.9	T9	2.3
	CSTB-3.5L110	●	5.5	11						7.5	T15	3.5
	CSTB-3.5L115	●	4.8	11.5						7.0	T10	2.5
	CSTB-3.5L115-S	●	4.8	11.5						6.5		
	CSTB-3.5L	●	12.5	8.4	M4x0.7	5.5	T15	3.5				
	CSTB-4	●	11.4	7.4								
	CSTB-4L060	●	6	2								
	CSTB-4L090	●	5.7	9						5.5		
	CSTB-4L115-S	●	5.5	11.5	6.5	T15	5.5					
	CSTB-4S	●	5.5	8								
	CSTB-4ST	●	M4x0.5	6.4	14.7	4	T8	1.3				
	CSTB-4SD	●	M4x0.7	5.5	8							
	CSTB-4M	●	M4x0.5	9.5	5.5	T15	3.5					
	CSTB-4F	●	M4x0.7	7	14.7			8.7				
	CSTB-4TS	●	M4x0.7	6.5	9	4.5	M5x0.8	7		T20	5.0	
	CSTB-5	●	12	7.5								
	CSTB-5S	●	9.5	5								
	CSTB-5L105	●	10.5	6.1								
	CSTB-5L120	●	12	6.5								
	CSTB-5L159	●	7.2	15.9	11.2							
	CSTB-5L163-S	●	6.9	16.3	11.3							
	CSPB-2L043	●	M2x0.4	2.7	4.3	2.5	6IP	0.7				
	CSPB-2H	●	2.6	3.4	1.6	7IP	1.1					
	CSPB-2.2	●	M2.2x0.45	3	6			3.9				
	CSPB-2.2SH	●	4	2	8IP	1.3						
	CSPB-2.5	●	M2.5x0.45	3.5			6	3.5				
CSPB-2.5S	●	4.2	1.7									
CSPB-2.5SH	●	3.3	5.2	3.3	7IP	1.1						
CSPB-3.5	●	M3.5x0.6	5.2	9	5.6	15IP	3.5					
CSPB-3.5S	●			6.5	3.1							
CSPB-4	●			11.6	7.4							
CSPB-4S	●	M4x0.7	5.5	8.2	4	20IP	5.0					
CSPB-5	●	M5x0.8	7	12	7.5							
SR34-514	●	M2.5x0.45	3.3	5.2	3.2			T7	0.9			
SR14-591	●	M5x0.8	6.6	13.5	7.6	T20	5.0					
SM40-143-H0	●	M4x0.7	5.6	14.3	8.4	T15	3.5					

● : Stocked items.

Shape	Part Cat. No.	Stock	Dimensions (mm)						Torque (N·m)	Applicable Tools
			a	øb	c	d	T / f			
	CSPD-1.8S	●	M1.8x0.35	2.4	3.3	1.4	6IP	0.7	TAC Mills	
	CSTD-3T	●	M3x0.5	4.3	7	4.5	T10	2.5		
	CSPD-3	●				4.2	10IP	2.5		
	CSTB-4.5L110P	●	M4.5x0.75	6.6	11.7	7	T15	3.5	TAC Toolholders S-type	
	CSPE-5L150	●	M5x0.8	9.2	15	9.8	20IP	7.5	TAC Mills DoOcto DoQuad	
	CSTC-2	●	M2x0.4	3.1	5.1	-	T6	0.7	TAC Drills TDJ (Former products)	
	CSTR-4L100	●	M4x0.7	5.7	10	5.5	T15	3.5	TAC Mills DoPent	
	SR16-212-01397	●	M5x0.8	6.4	12.5	6.8	T20/ T10	2.5	TAC Grooving & Parting Tools TetraCut	
	SR16-212-01397L	●								
	CST-3.5	●	M3.5x0.6	6	4.8	-	T9	2.3	TAC Mills	
	CST-3.5S	●			3.5	-				
	CST-5	●	M5x0.8	10	18	13	T25	5.0		
	CST-5S	●			12	7				
	CSTF-2L055-S	●	M2x0.4	2.7	5.5	3.8	T6			TAC Toolholders TurnTec
	SM2.5x0.45x8	●	M2.5x0.45	5	8	-	-	-	TAC External Toolholders C-type TAC Internal Toolholders C-type Tooling Systems TAC Cartridge CP-type	
	SM2.5x0.5x8	●	M2.5x0.5	5	8	-	-	-		
	SM3x0.5x6	●	M3x0.5	6	6	-	-	-		
	SM3x0.5x8	●			8	-	-	-		
	SM3x0.5x10	●			10	-	-	-		
	MSP-5	●	M5x0.8	6.1	7.9	4.9	2	1.5	TAC Toolholders M-type	
	MSP-6.3	●	M6.3x1	7.7	12.7	9.9	2.5	3.0		
	BHM3-8	●	M3x0.5	5.5	10	8	2	1.5	TAC Grooving & Parting Tools CGT-type GX-type TAC Drills	
	BHM4-8	●	M4x0.7	7	10.6	10	2.5	2.2		
	BHM4-10	●			12.6					
	BHM5-14	●	M5x0.8	9	17.6	14	3	3.0		
	BHM6-20-A	●	M6x1.0	10.5	24	20	4	5.0		
	BHM8-25U	●	M8	14	29.3	25	5	8.5		
	BHM8-30U	●			34.3	30				
	CSHM-3-8	●	M3	6	8	-	2	1.5		
	CSHB-4-A	●	M4	5.5	11	-	T15	2.0	TAC Grooving & Parting Tools CGD-type CGW-type CFGS-type CFGT-type TungCut	
	CSHB-6	●	M6	8.5	19	-	4	5.0		
	CSHB-6-A	●	M6	8.5	19	5.0				
	RT-1	●	M6	10	22.5	14	4	5.0	TAC Grooving & Parting Tools CGD-type GX-type TAC Mills	
	RT-2	●	M8	13	31	20	5	8.5		
	ASM6	●	M6	10	18	12	3	-	Tooling Systems TAC Cartridge PN-type TAC Cartridge CP-type TAC Mills	
	AJM5F	●	M5x0.5	9	13	8	2	-		
	AJM5	●	M5x0.8	9	13	8	2	-		

● : Stocked items.

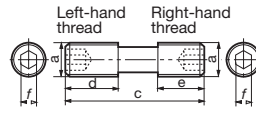
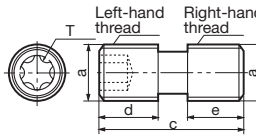
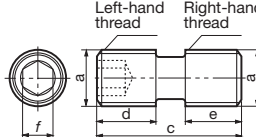
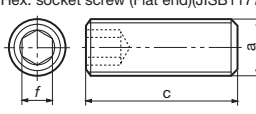
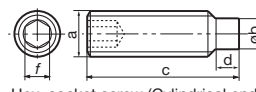
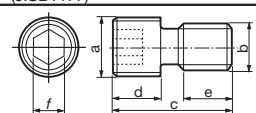

Screws

Shape	Part Cat. No.	Stock	Dimensions (mm)						Torque (N·m)	Applicable Tools	
			a	øb	c	d	e	f			
	ASM34S	●	M3	4.8	8	5		2	-		
	ASM34L	●			11	8			-		
	ASM54	●	M5x0.8	9	14	9		3	-		
	CHHM3.5-10	●	M3.5x0.6	6	13.5					TAC Grooving & Parting Tools CGD-type CGW-type CFGS-type CFGT-type TAC Drills Tooling Systems TAC Cartridge PN-type TAC Cartridge CP-type TAC Cartridge CE-type TAC Cartridge SP-type TAC Cartridge PNE-type	
	CHHM4-10		M4x0.7	7	14	10					
	CHHM5-14		M5x0.8	8.5	19	14					
	CHHM5-18	●			23	18					
	CHHM6-15		M6	10	21	15					
	CHHM6-20				-	20					
	CHHM6-25				31	25					
<p>Hex. socket head screw (JISB1176)</p>	CM3X0.5X6		M3x0.5	5.5	9	6				TAC Mills TAC Mill PS-series TAC Grooving & Parting Tools TungCut	
	CM3X0.5X10				13	10			2.5		2.2
	CM4X0.7X10		M4x0.7	7	14						
	CM4X0.7X12				16	12					
	CM4X0.7X14	●			18	14			3		3.0
	CM4X0.7X15				19	15					
	CM4X0.7X20	●			24	20					
	CM4X0.7X20-M0-A	●			6	24	20				
	CM5X0.8X8		M5x0.8	8.5	13	8					
	CM5X0.8X10-A	●			15	10					
	CM5X0.8X12	●			17	12					
	CM5X0.8X12-A	●			17	12					
	CM5X0.8X14	●			18	14					
	CM5X0.8X16				21	16					
	CM5X0.8X16-A	●			21	16					
	CM5X0.8X18				23	18					
	CM5X0.8X20-A	●			25	20					
	CM5X0.8X25-A	●			30	25					
	CM5X15		M5		20	15					
	CM6X1X16-A	●	M6x1.0	10	22	16					
	CM6X1X20-A	●			26	20					
	CM6X1X25-A	●			31	25					
	CM6X1.0X40-A	●			46	40					
	CM6X10		M6	10	16	10					
	CM6X15				21	15			5		8.5
	CM6X16				22	16					
	CM6X20				26	20					
	CM6X25				31	25					
	CM6X30-S	●			M6x1.0	10	35.7	28			
	CM8X1.25X20-A	●	M8x1.25	13	28	20					
	CM8X1.25X25-A	●			33	25			6		25.0
	CM8X30H	●			36	30			5		
	CM10X30		M10x1.5	16	30	20					
CM10X30H	●	16			38	30		8	40.0		
CM12X30H	●	M12x1.75	18	40	30			8	70.0		
CM16X40H	●	M16x2	24	54	40			10	100.0		
C0.375X1.125H	●	3/8-24UNF	14.27	38.11	28.58			5.55	35.0		
C0.500X1.375H	●	1/2-20UNF	19.05	47.63	34.93			7.94	70.0		
SD06-A3	●	M10x1.5	16	70	60			8	40.0		
SD08-98	●	M12x1.75	18	77	65			10	70.0		
	FSHM8-30	●	M8x1.25	11	30	27				TAC Mills	
	FSHM8-30H	●					5	25.0			
	FSHM10-40	●	M10	14	40	36.5					
	FSHM10-40H	●					6	40.0			
	SHCM4-10	●	M4x0.7	6	14	10				TAC Mills	
	SHCM4-12	●			16	12			3		3.0
	SHCM4-16	●			20	16					
	CTS-M6	●	M6x1	10	25	16.4			4	5.0	TAC Toolholders C-type (Be used KNMX inserts) TAC Grooving & Parting Tools CTW-type

Shape	Part Cat. No.	Stock	Dimensions (mm)						Torque (N·m)	Applicable Tools
			a	øb	c	d	e	T / f		
	MCS520-2.5	●	M5×0.8		20	7	6	2.5	3.0	TAC External Toolholders M-type C-type TAC Internal Toolholders M-type TAC Grooving & Parting Tools CTH-type
	MCS620-3	●	M6×1				7	3	6.0	
	MCS625-3	●	M6×1		25	10	8			
	MCS825-4	●	M8×1			12.5	6.5			
	MCS828-4	●	M8×1		28.5	12	10.5	4	8.0	
	NDS-8A	●	M8×1.25		30	11.5	11.5			
	NDS-8S	●	M8×1.25		20	8	8			
	DS-6T	●	M6		15	6	6		3.5	TAC Mills
	DS-6P	●	M6×1		21	7	7	15IP	6.0	
	FDS-8ST	●	M8×1		20	8	8	T27	10.0	
	FDS-8ST-18	●	M8×1		18	8	6			
	DS-6	●	M6×1		15	6	6	3	6.0	TAC Grooving & Parting Tools CTH-type TAC Threading Tools TT-type TAC Mills
	DS-8	●	M8×1.25		16	7	7	4	8.0	
	DS-8S	●	M8×1.25		13	5.5	5.5			
	DS-10	●	M10×1.5		26		12	5	8.0	
	FDS-6Z	●	M6×0.75		20.5	10	5.5	3	6.0	
	FDS-8	●	M8×1		26		10			
	FDS-8S	●	M8×1		20	8	8	4	8.0	
	FDS-8SS	●	M8×1		18.5		6.5			
 <p>Hex. socket screw (Flat end)(JISB1177)</p>	SSHM3-3		M3		3			1.5	1.0	TAC External Toolholders THC-type (former product) Tooling Systems TAC Cartridge PN-type TAC Cartridge CP-type TAC Cartridge CE-type TAC Cartridge SP-type TAC Cartridge PNE-type TAC Internal Toolholders Stream Jet Bar mini
	SSHM3-6		M3		6					
	SSHM4-4		M4		4			2	1.5	
	SSHM4-6		M4		6					
	SSHM4-8		M4		8					
	SSHM4-10		M4		10					
	SSHM4-14		M4		14					
	SSHM5-6	●	M5		6			2.5	2.0	
	SSHM5-10	●	M5		10					
	SSHM5-16		M5		16					
	SSHM6-12	●	M6		12			3	3.0	
	SSHM6-16		M6		16					
	SSHM6-18	●	M6		18					
	SSHM6-20	●	M6		20					
	SSHM8-8	●	M8		8			4	5.0	
	SSHM8-10	●	M8		10					
SSHM8-12	●	M8		12						
SSHM8-14	●	M8		14						
SSHM8-16	●	M8		16						
SSHM8-18	●	M8		18		14				
 <p>Hex. socket screw (Cylindrical end)(JISB1177)</p>	M5×7	●	M5		7		-	2.5	2.0	TAC Toolholders JT-type (Back clamping type)
	M5×8	●	M5	3.5	8	1.25	-			
	M5×10	●	M5		10		-			
	M6×30	●	M6	4	30	1.5	-	3	3.0	
	JDS-3525	●	M3.5×0.35	M2.5×0.45	7.5	3	2.5	2	1.0	TAC Toolholders JT-type (Back clamping type)
	JDS-5040	●	M5×0.5	M4×0.7	10	4	4	2.5	1.0	

● : Stocked items.

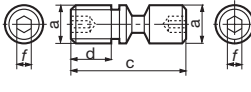
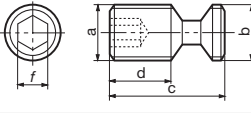
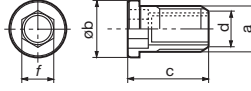
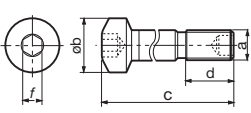
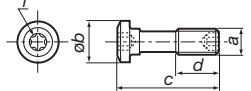
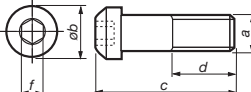
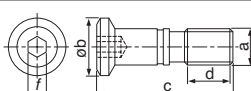
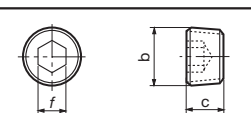
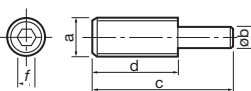
Screws

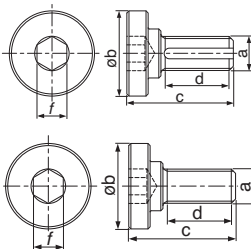
Shape	Part Cat. No.	Stock	Dimensions (mm)						Torque (N·m)	Applicable Tools	
			a	b	c	d	e	T / f			
 <p>LCS2 has a hex. socket in threaded end only.</p>	LCS2	●	M5	5	14			2	1.5	TAC External Toolholders P-type MS-type TAC Internal Toolholders P-type Tooling Systems TAC Cartridge PN-type	
	LCS3	●	M6	6	17	6.5		2.5	2.0		
	LCS3B	●			15						
	LCS4	●	M8	8		21	9.6		3		3.0
	LCS4K	●				17.5					
	LCS4CA	●				25					
	LCS5	●				20.5					
	LCS5CA	●									
	LCS6	●	M10	9.8	27.2	9.9		4	5.0		
	LCS8	●	M12	11.8	36	12.8		5	8.0		
LCS8C	●	M10	9.8	30.2	13.3		4	5.0			
	LCS22	●	M5	M5	10	4.7		2	1.5	TAC Toolholders P-type	
	LCS22A	●	M6	M6	10.7						
	LCS33	●	M5	M5	12	6.2					
	LCS43	●	M6	M6	13.5	7.3	2.5	2.0			
	DTS5-3.5	●	M5	6.3	8.65	M3.5		3.5	4.0	TAC External Toolholders S-type (35° Rhombic) TAC Internal Toolholders S-type TAC Grooving & Parting Tools CNG-type TAC Threading Tools ST-type Tooling Systems TAC Boring Bar Tools TAC Mill, TAC Endmill series	
	DTS5-3.5SS	●			6.8						
	DTS5-3.5S	●			7						
	DTS6-4	●	M6	7.7	10.2	M4	4	5.0			
	DTS6-4.5	●		7.5	10	M4.5	4.5	6.5			
	DLCS33	●	M5	9	31.5	10		3	3.0		
	DLCS43	●	M6	12	34	9.5		4	5.0		
	DLCS54	●	M8x1	14	41	11			7.0		
	DLCS64	●	M10x1	16	50	15		5	8.0		
	ACS-5W	●	M5	8	20	8.5		T15	4.0	TAC Toolholders D-type	
	ACS-6W	●	M6	10	26	12.1		T20	6.4		
	ACS3	●	M5x0.8	7.5	25.6	12-15		3	4.0	TAC Toolholders Turning A A-type	
	ACS4	●	M6x1	9	27.7	14-17		4	7.0		
	WCS3	●	M6	9.5	22.5	8		3	3.0	TAC Toolholders A-type	
	PT1/4GN	●		13.175	10	-		6	9.5	Oil Hole Plugs for TAC Drills TAD (Former products) TDX	
	1/8-28	●		9.728	7	-		5	8.0		
	LS-8		M8	6	33	20		4	5.0	TAC Toolholders H-type	
	CCS4-A	●								TAC Toolholders C-type for dimple ceramic inserts	
	BH5-10-A	●									
	BH4-10-A	●									
	BH-40050-A	●									
	TMBA-M10	●	M10x1.5	27	30	21		8	40.0		
	TMBA-M12	●	M12x1.75	33	36	26		10	70.0		
	TMBA-M12H	●	M12x1.75		34.5						
	TMBA-M16	●	M16x2	40	50	40		14	100.0		
	TMBA-M16H	●	M16x2								
	TMBA-M20	●	M20x2.5	50	56	42		17	150.0		
	TMBA-M20H	●	M20x2.5								
	TMBA-M24	●	M24x3	65	69	55		19	150.0		
	TMBA-M24H	●	M24x3								
	TMBA-0.500H	●	1/2-20UNF	33	33.9	25.4		7.94	70.0		
	TMBA-0.750H	●	3/4-16UNF	50	58.28	47.28		12.7	150.0		

● : Stocked items.

Shims

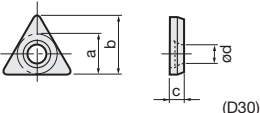
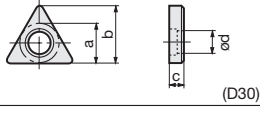
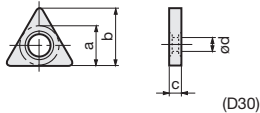
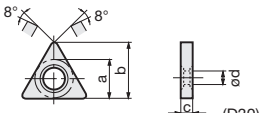
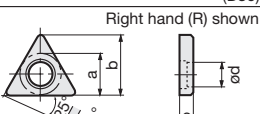
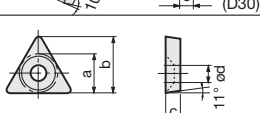
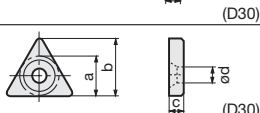
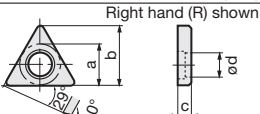
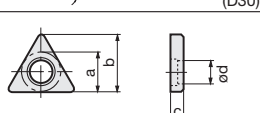
Shape (Carbide grade)	Part Cat. No.	Stock	Dimensions (mm)				Applicable Tools
			a	b	c	ød	
	AST322	●	9.3	13.2	3.2	4.4	TAC Toolholders Turning A A-type
	AST422	●	12.5	18	3.2	4.4	
	MST-322	●	9.1	12.9	3.24	5.8	TAC Toolholders M-type
	MST-432	●	12.5	17.9	4.8	7.3	
	MST-533		15.6	22.2		9.7	
	MST-644		18.8	26.6	6.4	11.3	
	LST317	●	9.3	13.2	2.7	5	TAC Toolholders A-type D-type P-type MS-type
	LST42	●	12.5	18	3.2	6.7	
	LST53	●	15.7	22.3	4.8	7.7	
	LST42K	●	10.9	15.6	3.2	6.7	
	LST317CA	●	9.3	13.2	2.7	5	Tooling Systems TAC Cartridge P-type (former product) TAC Cartridge PN-type
	LST42CA	●	12.5	18	3.2	6.7	
	ELST42	●	11.5	16.5	3.2	6.5	TAC Toolholders P-type
	ELST317	●					
	ELST317BR	●	8.5	12	2.7	4.9	
	ELST317BL	●					
	PAT-32	●	8.2	11.7	3.2	3.5	TAC External Toolholders C-type (positive) TAC Internal Toolholders C-type (positive)
	PAT-53*	●	13.4	19.8	4.8	5	
	NAT-32	●	9.5	13.4	3.2	3.5	TAC Toolholders C-type
	NAT-42E						
	LST317BR	●	9.3	13.2	2.7	5	TAC Internal Toolholders P-type
	LST317BL	●					
	SST32	●	8.5	11.9	3.2	5.4	TAC Toolholders S-type

Note: * marked shims are made of steel.

● : Stocked items.
▲ : Shortly unavailable

Shims

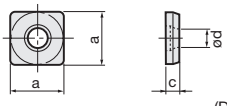
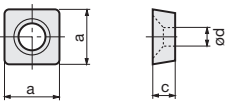
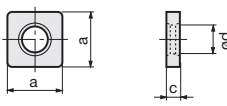
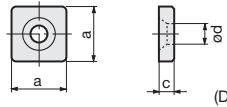
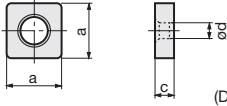
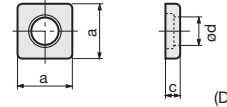
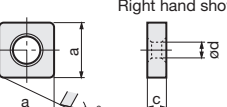
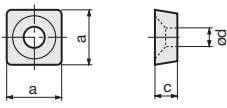
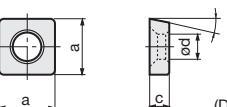
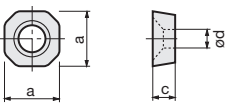
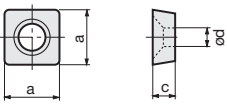
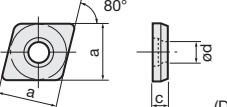
Shape (Carbide grade)	Part Cat. No.	Stock	Dimensions (mm)					Applicable Tools
			a	b	c	ød	e	
 (D30)	ASS422	●	12.5		3.2	4.4		TAC Toolholders Turning A A-type
 (D30)	ASS533	●	15.7		4.8	5.5		
	ASS634	●	18.9					
 (D30)	ELSS32	●	8.5		3.2	4.9		TAC Toolholders P-type A-type D-type
	LSS33	●	9.3		4.3	5		
	ELSS42	●	11.7		3.2	6.5		
	LSS42	●	12.5		3.2	6.7		
	ELSS53		14.7		4.8	8		
	LSS53	●	15.7			7.7		
	ELSS63	●	17.9			9.7		
	LSS63	●	18.9					
	ELSS84	●	24.2		6.4	12.9		
	LSS84	●	25.2		6.4	13.1		
 (D30)	NAS-42	●	12.7		3.2	3.5		TAC Toolholders C-type H-type
	NAS-04	●	31.5		6.4	9.1		
 (D30)	MSS-432	●	12.5		4.8	7.3		TAC Toolholders M-type
	MSS-442	●		6.4				
 (D30)	SSS32		8.5		3.2	5.4		TAC Toolholders S-type
 (D30)	LSS42BR	●	12.5		3.2	6.7		TAC Internal Toolholders P-type
	LSS42BL	●						
 (D30)	PAS-32	●	8.2		3.2	3		TAC External Toolholders C-type (positive) HP-type (former product) TAC Internal Toolholders C-type (positive) Tooling Systems TAC Cartridge C-type (former product) TAC Cartridge CP-type
	PAS-42	●	11.4			3.5		
	PAS-63*	●	17		4.8	5		
 (D30)	LSS42CA	●	12.5		3.2	6.7	8°	Tooling Systems TAC Cartridge P-type (former product) TAC Cartridge PN-type
	LSS53CA	●	15.7		4.8	7.7	10°	
 (D30)	FSSA1102	●	11.6		2	5.5	13°	TAC Mills TAW13 / EAW13
 (D30)	FSSP1102	●	11		2	5.5	17°	TAC Mills TPW13 / EPW13
 (D30)	ASC422	●	12.5		3.2	4.4		TAC Toolholders Turning A A-type
	ASC533	●	15.7		4.8	5.5		
	ASC634	●	18.9					

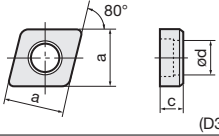
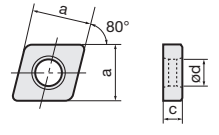
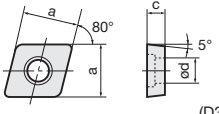
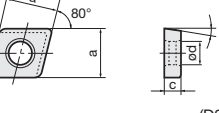
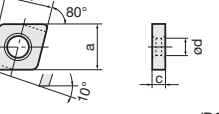
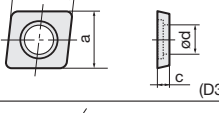
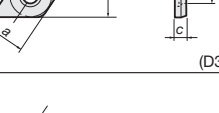
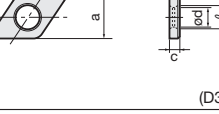
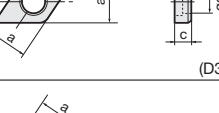
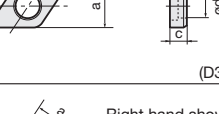
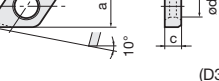

Note: * marked shims are made of steel.

● : Stocked items.

Shape (Carbide grade)	Part Cat. No.	Stock	Dimensions (mm)					Applicable Tools
			a	b	c	ød	e	
 (D30)	MSC-432	●	12.5		4.8	7.3	TAC Toolholders M-type	
	MSC-442	●						6.4
	MSC-533	●	15.6		4.8	9.7		
	MSC-543	●			6.4			
	MSC-634	●	18.8		11.3			
 (D30)	ELSC32	●	8.5		3.2	6.2	TAC Toolholders P-type D-type A-type	
	LSC42	●	12.5			6.5		
	ELSC42	●	11.7		4.8	7.7		
	LSC53	●	15.7			8.1		
	ELSC53	●	14.7			9.7		
	ELSC63	●	17.9					
	LSC63	●	18.9					
	SSC32	●	8.5			3.2		5.4
SSC4T3	●	11.4	4	6.6				
 (D30)	SSC4T3-P	●	11.4		4	6.6	Tooling Systems TAC Boring Bar Tools	
	SSC54-P	●	13.4					
 (D30)	LSC42CA	●	12.5		3.2	6.7	Tooling Systems TAC Cartridge P-type (former product) TAC Cartridge PN-type	
	LSC53CA	●	15.7		4.8	7.7		8° 10°
 (D30)	LSC42BR	●	12.5		3.2	6.7	TAC Toolholders P-type	
	LSC42BL	●						
 (D30)	ZSA1102	●	10.5	11	2	5.475	TAC Mills	
	ZSA1502	●	15.6	12.4		6		
 (D30)	ASD423	●	12.5		3.2	4.4	TAC Toolholders Turning A A-type	
	ASD432	●	12.5			4.8		4.4
 (D30)	ELSD32	●	8.5		3.2	4.9	TAC Toolholders P-type D-type A-type	
	ELSD42	●	11.7			6.5		
	LSD42	●	12.5			6.7		
	LSD42A							
	LSD43	●			4.8			
	LSD43A							
 (D30)	MSD-322	●	9.3		3.2	5.8	TAC Toolholders M-type	
	MSD-432	●	12.5			4.8		7.3
	MSD-442	●				6.4		
 (D30)	SSD32	●	8.5		3.2	5.4	TAC Toolholders S-type	
 (D30)	ELSD317BR	●	8.5		2.7	4.9	TAC Internal Toolholders P-type	
	ELSD317BL	●						
	LSD42BR	●	12.5		3.2	6.7		
	LSD42BL	●						

● : Stocked items.

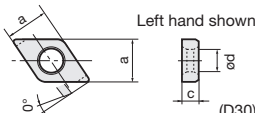
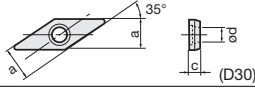
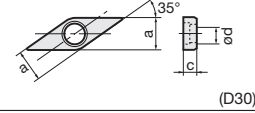
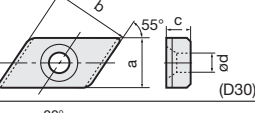
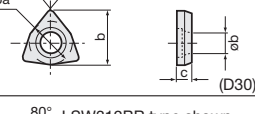
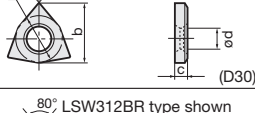
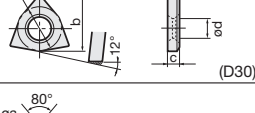
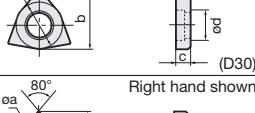
Shims

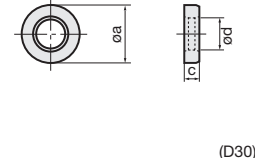
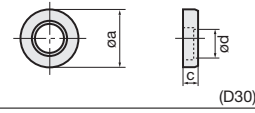
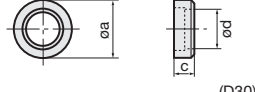
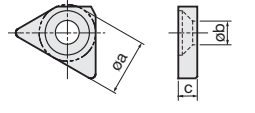
Shape (Carbide grade)	Part Cat. No.	Stock	Dimensions (mm)				Applicable Tools		
			øa	b	c	ød			
 <p>Left hand shown (D30)</p>	LSZ42BR	●	12.5		3.2	6.7	TAC Internal Toolholders P-type		
	LSZ42BL	●							
 <p>(D30)</p>	ASV322	●	9.3		3.2	4.4	TAC Toolholders Turning A A-type		
 <p>(D30)</p>	MSV-322	●	9.26		3.2	5.8	TAC External Toolholders M-type S-type TAC Internal Toolholders S-type		
	SSV32	●	8.4			5.4			
	SSV42	●	11			6.3			
 <p>Right hand shown (D30)</p>	CSK54R	●	9.4	14.8	4.8	3.5	TAC Toolholders C-type		
	CSK54L	●							
 <p>(D30)</p>	ASW322	●	9.33	11.5	3.2	4.4	TAC Toolholders Turning A A-type		
	ASW422	●	12.5	15.2					
 <p>LSW312BR type shown (D30)</p>	LSW312	●	9.33	11.5	2.7	5	TAC Toolholders D-type A-type		
	LSW42	●	12.5	15.5	3.2	6.7			
 <p>LSW312BR type shown (D30)</p>	LSW312BR	●	9.33	11.5	2.7	5	TAC Internal Toolholders P-type		
	LSW312BL	●							
 <p>(D30)</p>	MSW-432	●	12.8	15.8	4.8	7.3	TAC Toolholders M-type		
	MSW-533	●	16	19.7		9.7			
	MSW-633	●	19.2	23.7		11.3			
 <p>Right hand shown (D30)</p>	MSW-432BR	●	12.8	15.8	4.8	7.3	TAC Internal Toolholders M-type		
	MSW-432BL	●							
 <p>(D30)</p>	ASR420	●	12.5		3.2	4.4	TAC Toolholders Turning A A-type		
 <p>(D30)</p>	LSR32	●	8.9		3.2	5	TAC Toolholders P-type D-type		
	LSR32C	●	8.4			6.7			
	LSR42	●	12.1			5			
	LSR42C	●	9.9			6.7			
	LSR53C	●	14			8.2			
	LSR63C	●	17.2			9.7			
 <p>(D30)</p>	MSR-43	●	12.5		4.8	7.3	TAC Toolholders M-type		
	MSR-44	●				6.4			
 <p>(D30)</p>	SSR32	●	8.7		3.18	5.2	TAC Toolholders S-type		
 <p>Right hand shown</p>	G16EL/IR	●	9.5	-		3.2	4	Grooving tools GTGN	
	G16ER/IL	●				3.2			
	G16EL/IR-DT	●				3.97			5.4
	G16ER/IL-DT	●				3.97			



● : Stocked items.

Shape (Carbide grade)	Part Cat. No.	Stock	Dimensions (mm)			Applicable Tools	
			øa	ød	Lead angle		
	AE16-4DT	●	9.5	5.4	4°	TAC Threading Tools ST-type	
	AE16-3DT	●		5.4	3°		
	AE16-2DT	●		5.4	2°		
	A16-1DT	●		5.4	1°		
	AE16-0DT	●		5.4	0°		
	AE16-99DT	●		5.4	-1°		
	AE16-98DT	●		5.4	-2°		
	AE16-4	●		4	4°		
	AE16-3	●		4	3°		
	AE16-2	●		4	2°		
	A16-1	●		4.3	1°		
	AE16-0	●		4	0°		
	AE16-99	●		4	-1°		
	AE16-98	●		4	-2°		
	AN16-4DT	●		9.5	5.4		4°
	AN16-3DT	●			5.4		3°
	AN16-2DT	●			5.4		2°
	AN16-0DT	●			5.4		0°
	AN16-99DT	●	5.4		-1°		
	AN16-98DT	●	5.4		-2°		
	AN16-4	●	4		4°		
	AN16-3	●	4		3°		
	AN16-2	●	4		2°		
	AN16-0	●	4		0°		
	AN16-99	●	4		-1°		
	AN16-98	●	4		-2°		
	GXE16-98	●	9.5		4.0		-2°
	GXE16-98DT	●			5.4		-2°
	GXE16-99	●			4.0		-1°
	GXE16-99DT	●			5.4		-1°
	GXE16-0	●			4.0		0°
	GXE16-0DT	●			5.4		0°
	GXE16-1	●		4.3	1°		
	GX16-1DT	●		5.4	1°		
	GXE16-2	●		4.0	2°		
	GXE16-2DT	●		5.4	2°		
	GXE16-3	●		4.0	3°		
	GXE16-3DT	●		5.4	3°		
	GXE16-4	●		4.0	4°		
	GXE16-4DT	●		5.4	4°		
	GXE22-98DT	●		12.7	6.6		-2°
	GXE22-99DT	●					-1°
	GXE22-0DT	●					0°
	GX22-1DT	●					1°
	GXE22-2DT	●	2°				
GXE22-3DT	●	3°					
GXE22-4DT	●	4°					
GXN16-98	●	9.5	4.0	-2°			
GXN16-98DT	●		5.4	-2°			
GXN16-99	●		4.0	-1°			
GXN16-99DT	●		5.4	-1°			
GXN16-0	●		4.0	0°			
GXN16-0DT	●		5.4	0°			
GXN16-1	●		4.3	1°			
GXN16-2	●		4.0	2°			
GXN16-2DT	●		5.4	2°			
GXN16-3	●		4.0	3°			
GXN16-3DT	●		5.4	3°			
GXN16-4	●		4.0	4°			
GXN16-4DT	●		5.4	4°			
GXN22-98DT	●		12.7	6.6	-2°		
GXN22-99DT	●				-1°		
GXN22-0DT	●				0°		
GXN22-2DT	●				2°		
GXN22-3DT	●				3°		
GXN22-4DT	●	4°					

(D30)

● : Stocked items.

Shims

Shape (Carbide grade)	Part Cat. No.	Stock	Dimensions (mm)			Applicable Tools
			a	øb	Lead	
	NXE22-98	●	12.7	4.0	-2°	TAC Threading Tools ST-type
	NXE22-99	●			-1°	
	NXE22-0	●			0°	
	NXE22-1	●			1°	
	NXE22-2	●			2°	
	NXE22-3	●			3°	
	NXE22-4	●			4°	
	NXE27-98		15.9	4	-2°	
	NXE27-99				-1°	
	NXE27-0				0°	
	NXE27-1	●			1°	
	NXE27-2				2°	
	NXE27-3				3°	
	NXE27-4				4°	
	NXN22-98	●	12.7	4	-2°	
	NXN22-99	●			-1°	
	NXN22-0	●			0°	
	NXN22-1	●			1°	
	NXN22-2	●			2°	
	NXN22-3	●			3°	
	NXN22-4	●			4°	
	NXN27-98		15.9	4	-2°	
	NXN27-99				-1°	
	NXN27-0				0°	
NXN27-1	●	1°				
NXN27-2		2°				
NXN27-3		3°				
NXN27-4		4°				
(D30)						
	TSL12R	●				TAC Toolholders TurnTec
	TSL12L	●				
	TSL16R	●				
	TSL16L	●				
	TSL24R	●				
	TSL24L	●				
	TSL12RI	●				
	TSL12LI	●				
	TSL16RI	●				
	TSL16LI	●				
	CC44-A	●				TAC Toolholders C-type for dimple ceramic inserts
	CS44-A	●				
	CD44-A	●				
	CV34-A	●				
	CH44-A	●				

Parts for TAC Tools

14

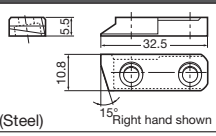
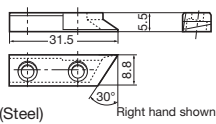
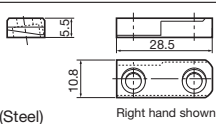
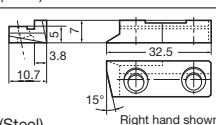
Shape (grade)	Part Cat. No.	Stock	Applicable Tools
 (Steel) Right hand shown	SL-1R SL-1L	● ●	TAC Grooving & Parting Tools GX-type (for external grooving)
 (Steel) Right hand shown	SL-2R SL-2L	● ●	TAC Grooving & Parting Tools GX-type (for internal grooving)
 (Steel) Right hand shown	SL-3R SL-3L	● ●	TAC Grooving & Parting Tools GX-type (for face grooving)
 (Steel) Right hand shown	SL-6R SL-6L	● ●	TAC Grooving & Parting Tools GX-type (for external grooving)

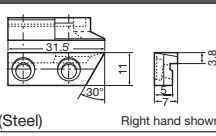
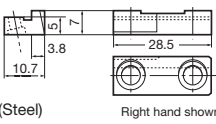
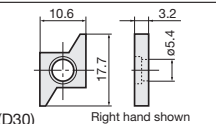
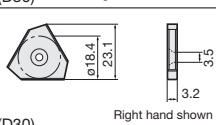
Shape (grade)	Part Cat. No.	Stock	Applicable Tools
 (Steel) Right hand shown	SL-7R SL-7L	● ●	TAC Grooving & Parting Tools GX-type (for internal grooving)
 (Steel) Right hand shown	SL-8R SL-8L	● ●	TAC Grooving & Parting Tools GX-type (for face grooving)
 (D30) Right hand shown	SGSR151 SGSL151	● ●	TAC Grooving & Parting Tools CNG-type (for internal grooving)
 (D30) Right hand shown	STN62R STN62L		TAC Mills

● : Stocked items.

Clamps

Shape	Part Cat. No.	Stock	Dimensions (mm)						Applicable Tools
			a	b	c	d	e	ℓ	
<p>e (Left-hand thread)</p>	MCL-5M	●	14.7	11	7.8	4	M5	10.8	TAC Toolholders M-type (former product)
	MCL-6	●	18.6	11.5	9.5		M6	13.8	
	MCL-8S	●	19.1	13.5	10.9	5	M8	13.6	
	MCL-8M	●	22.5					17	
	MCL-8L	●	25.5	14.5	4	20			
<p>e (Left-hand thread)</p>	MCPM-6	●	14.7	11.2	7.9	4	M5	10.8	TAC External Toolholders M-type
	MCPM-9	●	19.1	16.8	10.9	5	M8×1	13.6	
	MCPM-12	●	22.5					17	
	MCPM-20	●	18.6	9.5	9.5	4	M6	13.8	
	MCPM-21	●		12.2					
	MCPM-22	●	21.5	13.2	16.7				
	MCPM-30	●	25.5	16.8	10.9	5	M8×1	20	
	DCPM-33	●	16	9.3	10.5	2.4		8.5	TAC Toolholders D-type
	DCPM-43	●	21.2	11.5	13.5	3		13.2	
	DCPM-54	●	25.8	15.25	14	3.5			
	DCPM-64	●	28.4	15.5	16	4			
	ACP3S	●	22.8	9.5	10			15.0	TAC Toolholders Turning A A-type
	ACP3L	●	31.3	12	13			23.3	
	ACP4S	●	25.7	12	13			17.7	
	ACP5S	●	30.1	12.9	15	-	-	20.7	
	ACP6S	●	33.4	12.8	16.5	-	-	24.0	
	ACP3	●	17.9	10	10	6.5	6.3		TAC Toolholders A-type
	ACP4	●	25.9	13.9	12	7	10.8		
<p>Right hand shown</p>	CTC-3R	●	29	8.8	16	2.2	8		TAC Grooving & Parting Tools CTW-type
	CTC-3L	●							
	CTC-4R	●			17	3.2			
	CTC-4L	●							
	CTC-5R	●			18	4.2			
CTC-5L	●								
	CP81A	●	28	10.5	12	3.5	8		TAC Grooving & Parting Tools GX-type (Note) CP81A: With pusher "BP-3" (Note) CP81B: With pusher "BP-0"
	CP81B	●							
<p>TC-3 type shown, TC-4 : Left-hand thread</p>	TC-3	▲	19	12.5	8.3	-	-	-	TAC Toolholders THC-type (former product)
	TC-4	▲	21.6		8				
	CCR2	●	34.7	14.9	10.7	1.2	10.5		TAC Grooving & Parting Tools CGD-type
	CCL2	●							
	CCR3	●						2.2	
	CCL3	●							
	CCR4	●						2.8	
	CCL4	●							
	CCR5	●						3.2	
	CCL5	●							
	CCR6	●						3.9	
	CCL6	●							
CCR8	●	4.9							
CCL8	●								

● : Stocked items.
▲ : Shortly unavailable

Clamps

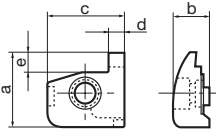
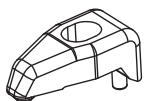
Shape	Part Cat. No.	Stock	Dimensions (mm)					Applicable Tools
			a	b	c	d	e	
 <p>Right hand shown</p>	CFG-3SR	●	22	11	23.1	2	6	TAC Grooving & Parting Tools CFGS-type CFGT-type
	CFG-3SL	●						
	CFG-4SR	●						
	CFG-4SL	●						
	CFG-4DR	●	32			3	16	
	CFG-4DL	●						
	CFG-5SR	●	22			4	6	
	CFG-5SL	●						
	CFG-5DR	●	32			4	16	
	CFG-5DL	●						
	CFG-6SR	●	23		5	7		
	CFG-6SL	●						
	CFG-6DR	●	33		5	17		
	CFG-6DL	●						
	CFG-8SR	●	28		27.1	7	8	
	CFG-8SL	●						
CFG-8DR	●	38	18					
CFG-8DL	●							
	CCP4-A	●						TAC Toolholders C-type for dimple ceramic inserts

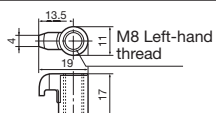
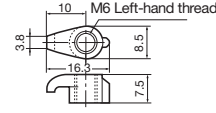
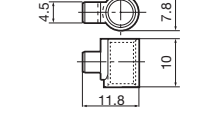
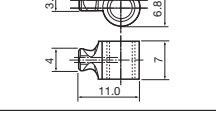
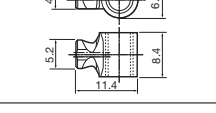
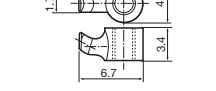
Shape	Part Cat. No.	Stock	Applicable Tools
 <p>M8 Left-hand thread</p>	NF-84A	●	TAC Toolholders C-type
 <p>M6 Left-hand thread</p>	CP536	●	TAC Mills
	CP91	●	TAC Threading Tools TT-type
	CP900	●	TAC Grooving Tools TGTS-type TGTT-type
	CP910	●	TAC Grooving Tools TGTS-type TGTT-type
	JCP-1	●	TAC Toolholders JT-type

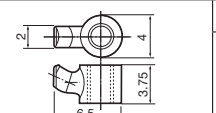
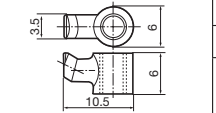
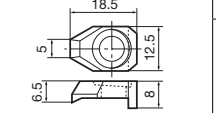
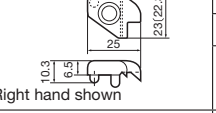
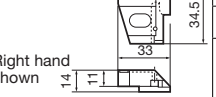
Shape	Part Cat. No.	Stock	Applicable Tools
	JCP-2	●	TAC Toolholders JT-type
	JCP-3 JCP-3N	●	
	CQ-1	●	TAC Toolholders Q-type (Former toolholders for PCD and PCBN)
 <p>Right hand shown</p>	CPK5R CPK5L	● ●	TAC Toolholders C-type (Be used KNMX inserts)
 <p>Right hand shown</p>	C11R-5 C11L-5	● ●	TAC Toolholders HP-type (former product)

● : Stocked items.

Clamp Sets

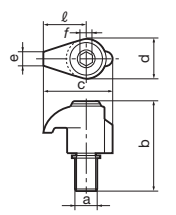
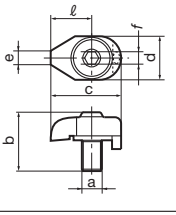
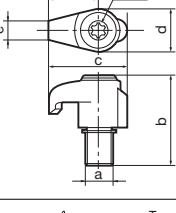
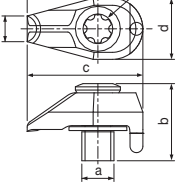
Shape	Part Cat. No.	Stock	Dimensions (mm)							Applicable Tools
			a	b	c	d	e	ℓ	T	
	CSG-5S	●	M5×0.8	13.5	13.8	7	1.8	8.5	2.5	TAC External Toolholders C-type (positive) TAC Internal Toolholders C-type Tooling Systems TAC Cartridge CP-type
	CSG-5	●		15.5						
	CSG-6S	●	M6×1	18	16.3	8.5	2.5	10	3	
	CSG-6	●		21.5						
	CSG-6L	●								
	CSG-8S	●	M8×1	21	20.5	11	3.5	12.5	4	
	CSG-8	●		23.5						
	CSW-00	●	M4×0.7	11.5	12	8	2	7.5	2.5	TAC External Toolholders C-type TAC Internal Toolholders C-type TAC Grooving & Parting Tools CGX-type Tooling Systems TAC Cartridge CE-type
	CSW-1	●	M5×0.8	16.5	16.5	9.5	4	10		
	CSW-0	●	M4×0.7	11.5	13.8	8.5	2.5	8		
	CSW-2	●	M6×1	20	20.5	11	6	13	4	
	CSW-40	●	M4×0.7	12	13.2	8	2	7.5	2.5	
	CSW-50	●	M5×0.8	15	16.9	10		9.5	3	
		CSP 16	●	M5×0.8	15.5	14.4	6.9	3.2	9.1	
CSP 22		●	M6×1	20	18.1	8.9	4.2	11.5	T20	
CSP 27		●	M8×1	23.5	24.4	11.9	3.9	15.6	4	
	CSY-15	●	M4×0.7	11.6	11.5	7	3	6	15IP	
	CSY-20	●	M5×0.8	12	18	9.5	4	11	20IP	

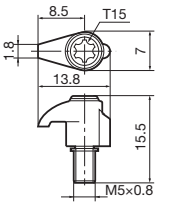
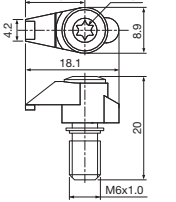
Shape	Part Cat. No.	Stock	Applicable Tools
	CSG-5T	●	TAC Mills
	CSX20	●	TAC Mills

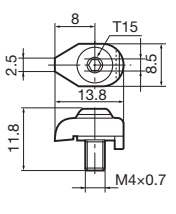
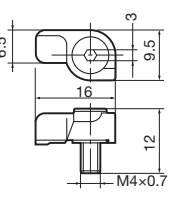
Shape	Part Cat. No.	Stock	Applicable Tools
	CSW-0T	●	TAC Mills
	CSL-4	●	TAC Mills

● : Stocked items.

Levers

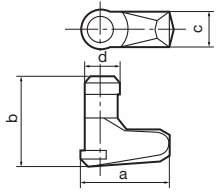
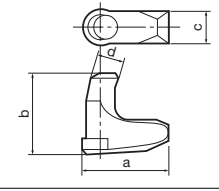
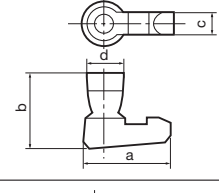
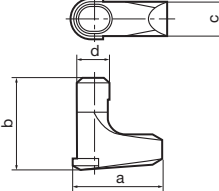
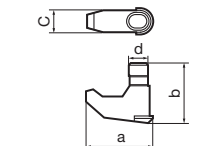
Shape	Part Cat. No.	Stock	Dimensions (mm)				Applicable Tools
			a	b	c	d	
	LCL3	●	10	12	3.7	3.6	TAC External Toolholders P-type MS-type TAC Internal Toolholders P-type Tooling Systems TAC Cartridge PN-type
	LCL4	●	14.6	14	4.7	4.7	
	LCL5	●	17.1	17	6	6	
	LCL6	●	20.5	21	7.5	7.5	
	LCL8	●	25.4	25.4	8.6	8.6	
	LCL3C	●	10.8	11.8	3.4	3	TAC Toolholders P-type
	LCL4C	●	13	13.4	3.7	3.4	
	LCL5C	●	18.6	17.7	4.7	4.5	
	LCL6C	●	20.5	19	6	5.7	
	LCL8C	●	24.2	23.5	7.5	6.2	
	LCL22N	●	7.5	6.5	2.6	2.06	TAC Internal Toolholders P-type Tooling Systems TAC Cartridge PN-type TAC Cartridge PNE-type
	LCL32N	●	10	7.8	3.2	3.2	
	LCL33NL	●	11.5	9.5	3.1	3.6	
	LCL33N	●	10	9.4	3.2	3.2	
	LCL43N	●	13.4	10	4.7	4.7	
	LCL33	●	10.1	12.1	3.6	3.7	TAC External Toolholders P-type D-type TAC Internal Toolholders P-type
	LCL33L	●	12	11.5	3.1	3.6	
	LCL43S	●	13.5	13.2	4.7	4.7	
	LCL43M	●					
	LCL44	●	16.1	14.6	4.7	4.7	
	LCL54	●	16.5	17.2	6.1	6	
	DLCL43	●	15.55	14	5	4.7	TAC Toolholders D-type
	DLCL54	●	19.1	19.1	6.1	6	
	DLCL64	●	21.5	21	7.5	7.5	

● : Stocked items.

Pins

Shape	Part Cat. No.	Stock	Dimensions (mm)						Applicable Tools
			øa	b	øc	ød	e	f	
	MLP32L	●	3.9	8.8	M5×0.8	5.6	3.5	2	TAC External Toolholders M-type TAC Internal Toolholders M-type
	MLP33		3.7						
	MLP34L	●	3.7	13.1	M6.3×1	7.8	5.5	2.5	
	MLP46	●	5	17.2					
	MLP46L	●		18.6					
	MLP58	●	6.2	21.9	M8×1	10.3	6.9	3	
	MLP68	●	7.8						
	MLP68L				24.1				
	MLP44	●	5	13.2	M6.3×1	7.1	5.5	2.5	TAC Internal Toolholders M-type
	MLP33L	●	3.7	10.4	M5×0.8	5.6	5.1	2	
	SW99	●	8	47.5					TAC Toolholders H-type (for heavy cutting)

Shape	Part Cat. No.	Stock	Applicable Tools
	SP-8		TAC Mills TAC Mill LS-series
	SP-6	●	TAC Mills MKS1000 (former product)
	BP-3	●	TAC Grooving & Parting Tools GX-type

Shape	Part Cat. No.	Stock	Applicable Tools
	BP-360	●	TAC Grooving & Parting Tools CTW-type
	BP-490	●	TAC Toolholders C-type (CK□NR/L-type)

● : Stocked items.

Chipbreaker Pieces

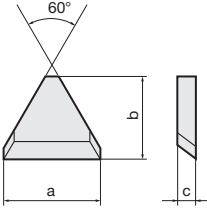
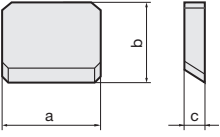
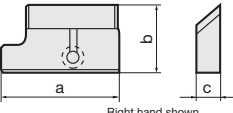
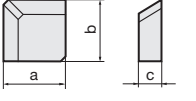
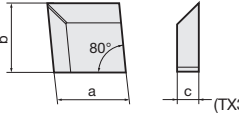
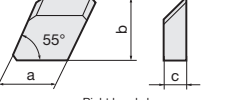
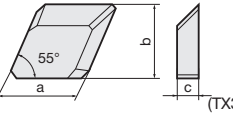
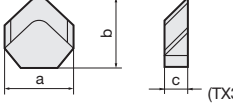
Shape (carbide grade)	Part Cat. No.	Stock	Dimensions (mm)				Applicable Tools
			a	b	c		
 (TX30)	CBT-2S	●	8.8	7.6	2	TAC Toolholders M-type C-type (negative) C-type (positive) Tooling Systems TAC Cartridge CP-type TAC Cartridge CE-type	
	CBT-2M	●	7.4	6.6			
	CBT-3S	●	13.3	12.1			
	CBT-3M	●	12.3	11.1	2.5		
	CBT-3L	●	11.3	10.1			
	CBT-4S	●	18.8	16.9			
	CBT-4M	●	17.8	15.9			
	CBT-4L	●	16.8	14.4			
	NCT-2S		14.2	11.8			
	NCT-2M	●	13	10.8	2.5		
	NCT-2L		11.9	9.8			
	 (TX30)	CBS-3S	●	9.5	8.3		2
CBS-3M		●	7.3				
CBS-4S		●	12.7	11.6	2.5		
CBS-4SN		●					
CBS-4M		●		10.6			
CBS-4L		●		9.1			
NCS-3S				11.2			
NCS-3M		●		10.2			
NCS-3L		8.7					
 Right hand shown (TX30)	B11 R-5	●	24	13	5	TAC Toolholders HP-type (former products)	
	B11 L-5	●					
 (TX30)	CBS-4SN	●	11.5	11.5	2.5	TAC Toolholders M-type C-type (negative)	
	CBS-4MN	●	10.5	10.5			
	CBS-4LN	●	9	9			
	NCS-3SN		11.2	11.2			
	NCS-3MN	●	10.2	10.2			
	NCS-3LN		8.7	8.7			
 (TX30)	CBC-4SN	●	11.5	11.5	2.5	TAC Toolholders M-type	
	CBC-4MN	●	10.5	10.5			
	CBC-4LN	●	9.5	9.5			
 Right hand shown (TX30)	CBD-4SR	●	12.7	11.5	2.5	TAC Toolholders M-type	
	CBD-4MR	●		10.5			
	CBD-4ML	●		9.5			
	CBD-4LR						
 (TX30)	CBD-4SN	●	11.5	11.5	2.5	TAC Toolholders M-type	
	CBD-4MN	●	10.5	10.5			
 (TX30)	CBR-4SN	●	12.7	11.9	2.5	TAC Toolholders M-type	
	CBR-4MN	●		10.9			

● : Stocked items.

Springs (Springs for Shims)

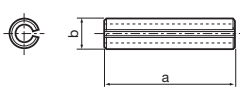
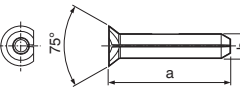
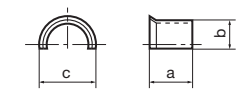
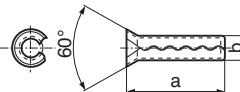
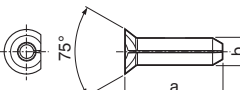
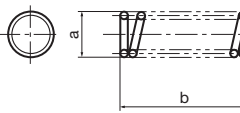
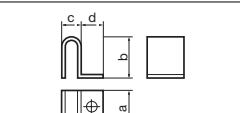
Shape (carbide grade)	Part Cat. No.	Stock	Dimensions (mm)					Applicable Tools
			a	b	c	d		
	SP-2.5	●	12	2.7				TAC Toolholders Turning A A-type
	SP-16-L14	●	13.6	2.85				TAC Toolholders TurnTec
	LSP3	●	5.5	3	5.9			TAC External Toolholders P-type D-type
	LSP3L	●	7					
	LSP4	●		6	4	7.6		
	LSP4S	●						
	LSP5	●	8.5	4.5	8.8			TAC Internal Toolholders P-type Tooling System TAC Cartridge PN-type
	LSP6	●	11	5.9	10.9			
	LSP6C	●	8.5	4.8	9.3			
	LSP8	●	12	10	15.4			
	PSP-2.5	●	10	2.7				TAC Toolholders HP-type (former products) THC-type (former products) C-type (former products)
	PSP-4.0	●	16	4.2				
	PSP301	●	7.6	3				
	PSP-16	●	9.75	2.85				TAC Toolholders TurnTec
	BP-0	●	3.6	13				TAC Toolholders C-type (Be used KNMX inserts) D-type A-type
	BP-5-A							
	BP-7	●	7	11				
	BP-8.8	●	8.8	10				C-type for dimple ceramic inserts TAC Grooving & Parting Tools CGD-type GX-type
	BP-9	●	8.3					
	BP-10	●	9.1	13				CFGS-type CFGT-type
	SP913	●	9	13				
	BSP-1	●	7.8	7.5	4.8	6		Adapters for TAC Boring Tools

● : Stocked items.

Coolant Supply Attachment

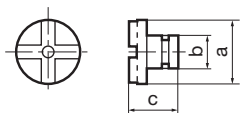
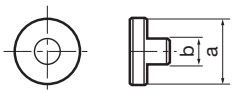
Shape	Part Cat. No.	Stock	Dimensions (mm)					Applicable Tools
			a	b	c	Thread		
	EA-20	●	20	10	15		TAC Internal Toolholders	
	EA-25	●	25					
	EA-32	●	32	16				
	CA-16	●	16	8		M6	TAC Grooving & Parting Tools TungCut	
	CA-20	●	20	8.5		M6		
	CA-25	●	25	11.5		R1/8		
	CA-32	●	32	11.5		R1/8		
	CA-40	●	40	11.5		R1/8		

Pistons

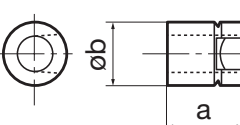
Shape	Part Cat. No.	Stock	Dimensions (mm)				Applicable Tools	
			a	øb				
	DPIS33	●	12.6	9			TAC Toolholders D-type	
	DPIS43	●	11.8	10				
	DPIS44	●	13.4	10				
	DPIS54	●	16		13			
	DPIS64	●			15			

Nuts

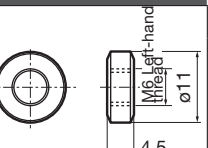
Shape	Part Cat. No.	Stock	Applicable Tools
	SRW11		TAC Mills Adjusting wedge for TFP4000I (Former product)

Coolant Pipe & Nozzle

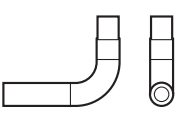
Shape	Part Cat. No.	Stock	Applicable Tools
	PNZ5	●	TAC Grooving & Parting Tools TungCut

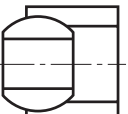
Shape	Part Cat. No.	Stock	Applicable Tools
	CNZ125	●	TAC Grooving & Parting Tools TungCut

● : Stocked items.

Sizing Plates

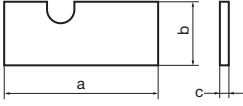
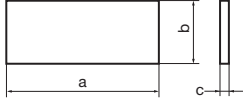
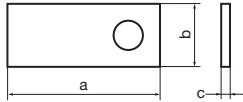
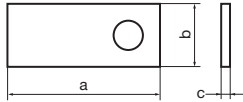
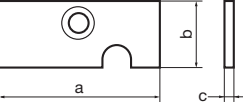
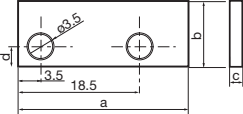
Shape	Part Cat. No.	Stock	Dimensions (mm)					Applicable Tools
			a	b	c	d		
	S0816A		55	15.5	0.8		Tooling Systems TAC Cartridge PN-type TAC Cartridge CP-type	
	S1016A				1			
	S0816B	●	50		0.8			
	S1016B	●			1			
	S0816C		45		0.8			
	S1016C				1			
	S0820A		61		0.8			
	S1020A				1			
	S0820B	●	54.5		0.8			
	S1020B	●			1			
	SM-00	●	18		8	1		
	SW04	●	25.5	5.8	0.25		TAC Drills TDP	
					0.5			
					1			
	SW05	●	37		8.3			0.25
	SW06	●	36	10.8	0.5			
					1			
	SW08	●	35.5	12.3	2			
	S0810	●	40	11	0.8		Tooling Systems TAC Cartridge P-type, C-type (Former products)	
S1010	●	1						
 <p>Attached with fix screw and wrench.</p>	PSTR08	●	24	11	1.5		Tooling Systems TAC Cartridge PN-type TAC Cartridge CP-type TAC Cartridge CE-type TAC Cartridge SP-type TAC Cartridge PNE-type	
	PSTL08	●						
	PSTR10	●	42		16.5			2
	PSTL10	●						
	PSTR12	●	47		19			2
	PSTL12	●						
	AP0801	●	26	9.5	0.5	3	TAC Drills TungDrillBig	
	AP0802	●			1			
	AP0803	●			1.5			
	AP0804	●			2			
	AP0805	●			2.5			
	AP1101	●	30		11.5	0.5		5
	AP1102	●				1		
	AP1103	●				1.5		
	AP1104	●				2		
	AP1105	●				2.5		
	AP1106	●				3		

SW04 is composed of three plates and SW05 to SW08 are composed of four plates.

Note on fixing screws: PSTR/L08 is attached with CSSM2-4 and other types are attached with CSHM3-8.

● : Stocked items.

Washers

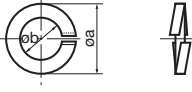
Shape	Part Cat. No.	Stock	Dimensions (mm)					Applicable Tools
			øa	øb				
	VA4	●						TAC Mills
	VA5	●						
	VA6	●	10.5	6.1				

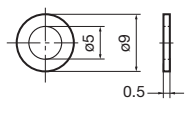
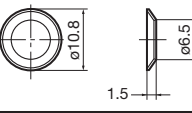
Shape	Part Cat. No.	Stock	Applicable Tools
	CPW5	●	TAC Grooving & Parting Tools CFGs-type
	CDW6	●	TAC Grooving & Parting Tools CTW-type

Wrenches and Drivers

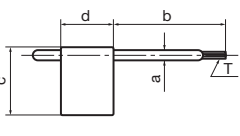
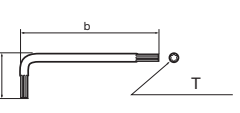
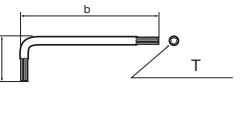
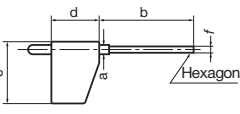
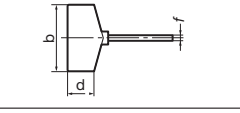
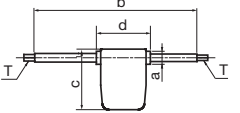
Shape	Part Cat. No.	Stock	Dimensions (mm)						Applicable Tools
			a	b	c	d	f	T	
	CRW23	●							TAC Grooving & Parting Tools TungCut
	CRW33	●							
	T-6F	●	1.7	34.5	15	15		T6	TAC Toolholders
	T-7F	●	2					T7	TAC Grooving & Parting Tools
	T-8F	●	2.3	39	19	19		T8	TAC Threading Tools
	T-9F	●	2.5	42.5				T9	Tooling systems
	T-15F	●	3.3	45	27	22		T15	
	T-20F	●	3.9	49	30			T20	
	IP-6F	●	1.7	34.5	15	15		6IP	
	T-6L	●		48	16			T6	TAC Toolholders
	T-8L	●					T8	TAC Grooving & Parting Tools	
	T-9L	●					T9	TAC Threading Tools	
	T-15L	●		59	22		T15		
	KEYV-T20	●		60	22			T20	Endmills
	KEYV-T25	●		65	23			T25	TungMeister
	KEYV-T30L	●		190	37			T30	TAC Toolholders
	KEYV-T40L	●		208	43			T40	TurnTec
	KEYV-T50L	●		232	48			T50	
	P-2F	●	4	39.5	20	12.5	2		TAC Toolholders
	P-2.5F	●	5	45	25	20	2.5		Tooling systems
	P-2.5T	●		42		15	2.5		TAC Grooving & Parting Tools
	T-2010/5	●	6.5	85	28	25	-	T10/ T20	TetraCut

● : Stocked items.

Wrenches and Drivers

Shape	Part Cat. No.	Stock	Dimensions (mm)						Applicable Tools
			a	b	c	d	f	T	
	P-2	●					2		TAC Grooving & Parting Tools
	P-2.5	●					2.5		
	P-3	●					3		
	P-3.5	●					3.5		
	P-4	●					4		
	P-4.5	●					4.5		
	P-5	●					5		
	P-6	●					6		
	TP-3A	●		70		45.5	3		TAC Mills
	TP-4	●		85		53	4		
	TP-5	●		85		53	5		
	T-15T	●		65		45		T15	TAC Mills
	T-20T	●	5					T20	
	T-27T	●		85		42		T27	
	IP-20T	●	5	80		45		20IP	
<p>Handle shape somewhat varies depending on the type number from the above figure.</p>	T-6D	●	2.5	45	70			T6	TAC Mills TAC Drills
	T-7D	●	2					T7	
	T-8D	●	2.6	61	67.5			T8	
	T-9D	●	3.0	65	80			T9	
	T-10D	●	3.3	70	90			T10	
	T-15D	●	3.65	71	100			T15	
	T-20D	●	4.6	90				T20	
	T-25D	●	4.4	87	86			T25	
	IP-6DB	●		45	70			6IP	
	IP-7D	●	2.6	45	70			7IP	
	IP-8D	●	2.8	56	69			8IP	
	IP-10D	●	3.3	71	89			10IP	
	IP-15D	●	3.9	70	100			15IP	
	IP-20D	●	4.6	90	100			20IP	
	KS-21	●	21	195					TAC Mills TMS
	KS-24	●	24	215					
	KS-27	●	27	235					
	KS-32	●	32	275					
	KS-36	●	36	305					
	M-1000	●							A burn inhibitor
	BT15S	●	3.9	50	90		6	T15	TAC Mills
	BT15M	●	3.9	50	118		6	T15	
	BT20S	●	4.6	50	90		6	T20	
	BT20M	●	4.6	50	118		6	T20	
	BLD IP15/S7	●	3.9	50	90		6	15IP	
	BLD IP20/S7	●	4.6	50	90		6	20IP	
	BLD IP20/M7	●	4.6	50	118		6	20IP	
	H-TB	●		100	37		6		TAC Mills
	H-TBS	●		75	37		6		
	KEYV-S05	●	4	5.5	100				TungMeister Endmills
	KEYV-S06	●	5.4	8	125				
	KEYV-S08	●	6.6	10	150				
	KEYV-S10	●	7.7	13	175				
	KEYV-S12	●	9.4	16	250				
	KEYV-177	●	29	110					
	KEYV-217	●	29	110					TungGun
	KGDT-100	●	32	108.5					
	KGDT-110	●	32	108.5					TungGun
	KGDT-120	●	32	108.5					
	KGDT-130	●	32	108.5					
	KGDT-140	●	32	108.5					
	KGDT-150	●	32	108.5					

● : Stocked items.

Locators

Part Cat. No.	Stock		Applicable Tools
	R	L	
LD150R	●		TXD15125R ~ TXD15315R
LD440R/L	●	●	TMD44 TGD4400R/L-A TFD44
LD442R/L	●		EGD4400R
LD540R/L	●		TMD54
LE302R	●		ESE3050R (RS**) ~ 3063R (RS**)
LE303R/L	●		TSE3003R/LIA ~ 3006R/LIA
LE402AR	●		ESE4050RA ESE4063RA
LE403R/L	●		TSE4003R/LIA TSE4004R/LIA ESE4003RIA-S32
LE405R/L	●		TSE4005R/LIA ~ 4012R/LIA
LE413R/L	●		THE40
LE444R/L	●	●	TME4403R/LI ~ 4405R/LI TME4403R/LB ~ 4405R/LB EME4405R ~ 4404RI
LE446R/L	●	●	TME4406R/LI ~ 4412R/LI TME4406R/LB ~ 4412R/LB
LE540R/L	●	●	TME54
LF440R/L	●	●	THF44
LF540R/L	●		THF54
LF602R	●		ERF6050R ~ ERF6063R
LF602R/L	●		TRF6003R/LI ~ TRF6006R/LI TRF6008R/LI ~ TRF6012R/LI
LMS56R/L			MS08R/L ~ MS12R/L
LN423R/L	●		TGN42
LN645R/L			TPN64
LP403R/L	●		TSP4003R/LIA ~ TSP4004R/LIA TFP4004R/LIA
LP405R/L	●		TSP4005R/LIA ~ TSP4012R/LIA TFP4005R/LIA ~ TFP4012R/LIA
LP413R/L	●		TGP41 TGP42
LP514R/L	●		TGP51
LPP16R	●		TPP16
LR602R/L	●		ERD6050RA ~ ERD6063RA
LR603R/L	●		TRD6003R/L TRD6004R/L ~ TRD6008R/L
LV525R/L	●	●	VSN 1
LV530R/L			VSN 2
LV556R/L			VSN60
LW400R	●		EFP4063R
LW400R/L	●		TFD44 TFP4000 SFP4000
LW402R	●		EFP4050R

● : Stocked items.

Insert locking wedges

Part Cat. No.	Stock		Applicable Tools
	R	L	
FDS-8SST			EDPD09063R EDPD09063RB
FDS-8ST-18	●		EDP09080R EDPD09080RB DPD09100R~DPD09160R DPD09100RB~DPD09160RB
FW-242R/L			ø63
FW-243R/L	●		ø80~100
FW-245R/L			ø125 ~
FW304R/L-D			DAD15 DPD15 EDPD15 QPP15
LE302R	●		ESE3050R (RS**) ~ 3063R (RS**)
WF150R			TXD15125R ~ TXD15315R
WF310R/L	●		TGP4100BA TGP4103R/LIA
WF330N	●		TSE4003R/LIA TSE4004R/LIA ESE4003RIA-S32 TSP4003R/LIA ~ TSP4004R/LIA TFP4004R/LIA
WF330R/L	●		TSE3003R/LIA ~ 3006R/LIA
WF444R/L	●	●	TME4403R/LI ~ 4405R/LI TME4403R/LB ~ 4405R/LB EME4405R ~ 4404RI TME4406R/LI ~ 4412R/LI TME4406R/LB ~ 4412R/LB
WF500R	●		TSE4005R/LIA ~ 4012R/LIA TSP4005R/LIA ~ TSP4012R/LIA TFP4005R/LIA ~ TFP4012R/LIA
WF500R/L	●		TMD54 TGP51 THF54
WF50R/L			TME54
WF602R	●		ERF6050R ~ ERF6063R
WF603R/L	●		TRF6003R/LI ~ TRF600R/LI
WF608R/L	●		TRF6008R/LI ~ TRF6012R/LI
WN645R/L			TPN64
WP193TR/L	●	●	EGD4400R
WP440R/L	●	●	TMD44 TGD4400R/L-A TFD44 TGP4100IA ~ TGP4112R/LIA TGP42 THF44 THE40
WR602R/LW	●		ERD6050RA ~ ERD6063RA
WR603R/L	●		TRD6003R/L TRD6004R/L ~ TRD6008R/L
WT402R	●		ESE4050RA ESE4063RA
WT402R/L			EME4450RB ~ 4404RB

● : Stocked items.

Locator adjusting wedges

Part Cat. No.	Stock		Applicable Tools
	R	L	
FW-305	●		TFD44 TFP40 SFP4000 EFP4063
FW325R/L-D			DAD15 QPP15 DPD15 EDPD15

Fine adjusting screws

Part Cat. No.	Stock		Applicable Tools
	R	L	
AJM5	●		DPD09 EDPD09
ASM34L	●		DPD24

J Series for Small Lathes

Cat. No.	Fixing screw	Stock	Wrench	Stock	Substitution (page)
JSXGR/L1010K8	CSTB-4SD	●	T-8F	●	JSXGR/L1010K8-C (8-21)
JSXGR/L1212K8					JSXGR/L1212K8-C (8-21)
JSXBR/L1010K8			(●)	(T-8L*)	JSXBR/L1010K8-C (8-22)
JSXBR/L1212K8					JSXBR/L1212K8-C (8-22)
JSVGRL1010K	CSTB-3S	●	T-9F	●	JSVGRL1010K-C (8-49)
JSVGRL1212K					(T-9L*)

* Parts in parenthesis are optional parts.

● : Stocked items.

Replacement Parts for Former PS Series TAC Mills

■ TGD4400

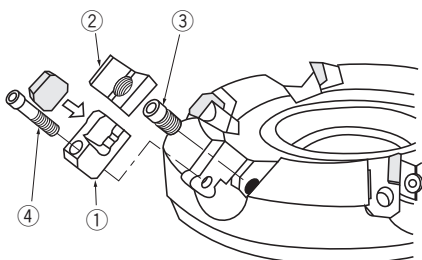

No.	Part Name	Part Cat. No.			
		For TGD4403R/L	Stock	For TGD4404R/L~4412R/L	Stock
①	Locator	LD443R	●	LD443R	●
		LD443L		LD443L	
②	Insert locking wedge	WP193TR	●	WP194TR	●
		WP193TL	●	WP194TL	●
③	Wedge fixing screw	DS-8	●	DS-8	●
④	Locator fixing screw	CM4×0.7×14	●	CM4×0.7×14	●
-	T-handle wrench	TP-4	●	TP-4	●

■ TGD5400

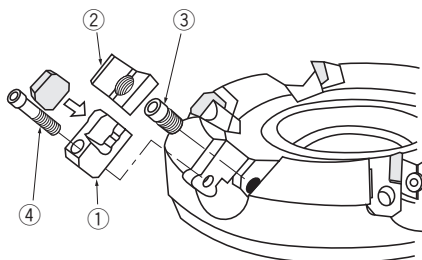

No.	Part Name	Part Cat. No.	Stock
①	Locator	LD544R	●
		LD544L	
②	Insert locking wedge	WP803TR	●
		WP803TL	●
③	Wedge fixing screw	DS-8	●
④	Locator fixing screw	CM4×0.7×14	●
-	T-handle wrench	TP-4	●

■ TGP4100

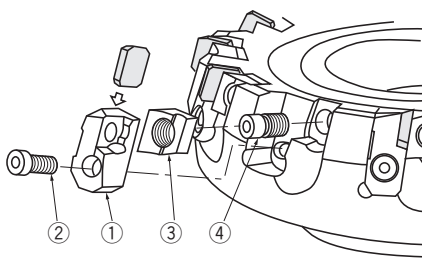

No.	Part Name	Part Cat. No.			
		For TGP4103R/L	Stock	For TGP4104R/L~4212R/L	Stock
①	Locator	LP413R	●	LP413R	●
		LP413L		LP413L	
②	Locator fixing screw	CM4×0.7×14	●	CM4×0.7×14	●
③	Insert locking wedge	WP103R	●	WP104RA	●
		WP103L	●	WP104LA	●
④	Wedge fixing screw	DS-8	●	DS-8	●
-	T-handle wrench	TP-4	●	TP-4	●

■ TGP4100B

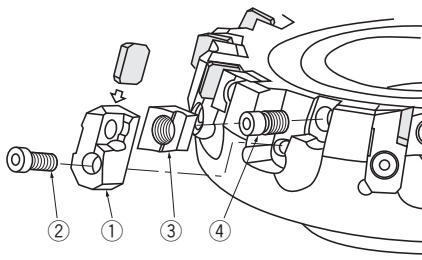

No.	Part Name	Part Cat. No.	Stock
①	Locator	LP413R	●
		LP413L	
②	Locator fixing screw	CM4×0.7×14	●
③	Insert locking wedge	WP103R	●
		WP103L	●
④	Wedge fixing screw	DS-8	●
-	T-handle wrench	TP-4	●

Note : For TGP4104R/LB ~ TGP4112R/LB

■ TGP4200

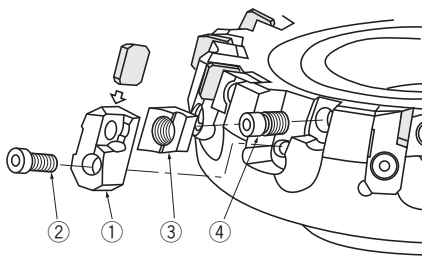

No.	Part Name	Part Cat. No.			
		For TGP4203R/L	Stock	For TGP4204R/L~4212R/L	Stock
①	Locator	LP413R	●	LP413R	●
		LP413L		LP413L	
②	Locator fixing screw	CM4×0.7×14	●	CM4×0.7×14	●
③	Insert locking wedge	WP103R	●	WP104RA	●
		WP103L	●	WP104LA	●
④	Wedge fixing screw	DS-8	●	DS-8	●
-	T-handle wrench	TP-4	●	TP-4	●

● : Stocked items.

Replacement Parts for Former PS Series TAC Mills

TGP5100 I

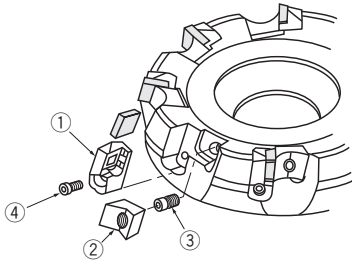

No.	Part Name	Part Cat. No.	Stock
①	Locator	LP514R	●
		LP514L	
②	Insert locking wedge	WP374TR	●
③	Wedge fixing screw	DS-8	●
④	Locator fixing screw	CM4×0.7×14	●
-	T-handle wrench	TP-4	●

Note : For TGP5104R/LI ~ TGP5112R/LI

TGN4200

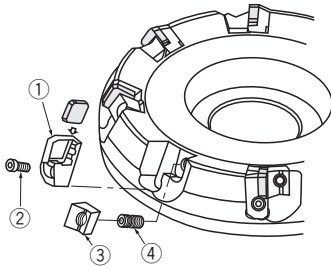

No.	Part Name	Part Cat. No.	Stock
①	Locator	LN423R	●
		LN423L	
②	Locator fixing screw	CM4×0.7×14	●
③	Insert locking wedge	WM104RA	●
		WM104LA	●
④	Wedge fixing screw	DS-8	●
-	T-handle wrench	TP-4	●

Note : For TGN4203R/L ~ TGN4212R/L

THE4000

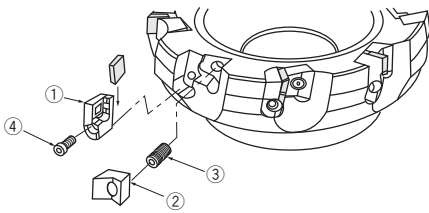

No.	Part Name	Part Cat. No.	Stock
①	Locator	LE413R	●
		LE413L	
②	Insert locking wedge	WP813TR	●
		WP813TL	
③	Wedge fixing screw	DS-8	●
④	Locator fixing screw	CM4×0.7×14	●
-	T-handle wrench	TP-4	●

Note : For THE4003R/L ~ THE4006R/L

THF4400

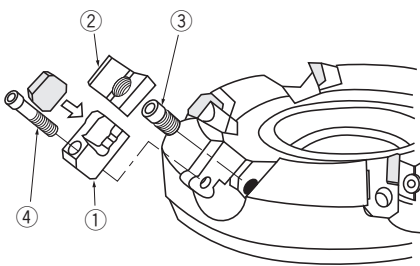

No.	Part Name	Part Cat. No.	Stock
①	Locator	LF443R	●
		LF443L	
②	Insert locking wedge	WP813TR	●
		WP813TL	
③	Wedge fixing screw	DS-8	●
④	Locator fixing screw	CM4×0.7×14	●
-	T-handle wrench	TP-4	●

Note : For THF4403R/L ~ THF4412R/L

THF5400

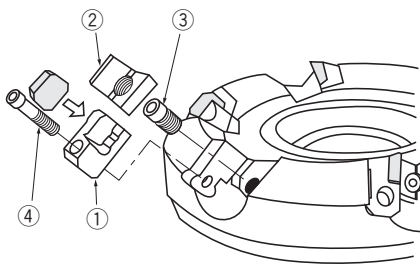

No.	Part Name	Part Cat. No.	Stock
①	Locator	LF543R	
		LF543L	
②	Insert locking wedge	WP803TR	●
		WP803TL	●
③	Wedge fixing screw	DS-8	●
④	Locator fixing screw	CM4×0.7×14	●
-	T-handle wrench	TP-4	●

Note : For THF5403R/L ~ THF5412R/L

● : Stocked items.

Replacement Parts for Former PS Series TAC Mills

TUD5600

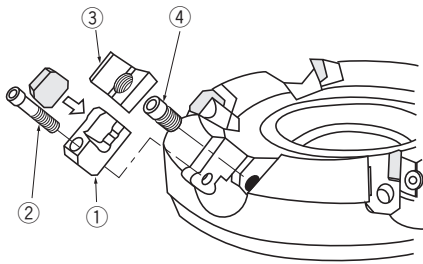

No.	Part Name	Part Cat. No.	Stock
①	Locator	LD563R	●
		LD563L	
②	Insert locking wedge	WP803TR	●
		WP803TL	●
③	Wedge fixing screw	DS-8	●
④	Locator fixing screw	CM5×0.8×18	
-	T-handle wrench	TP-4	●

Note : For TUD5603R/L ~ TUD5612R/L

TSP4000 I

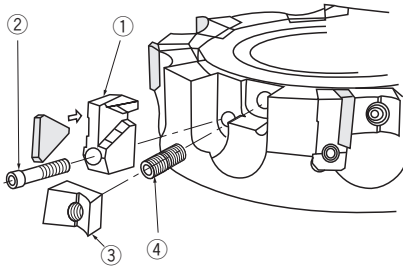

No.	Part Name	Part Cat. No.			
		For TGD4403R/L	Stock	For TGD4404R/L-4412R/L	Stock
①	Locator	LP403R	●	LP405R	●
		LP403L		LP405L	
②	Locator fixing screw	CM4×0.7×14	●	CM4×0.7×14	●
③	Insert locking wedge	WP153T	●	WP155T	●
④	Wedge fixing screw	DS-8	●	DS-8	●
-	T-handle wrench	TP-4	●	TP-4	●

TSE3000

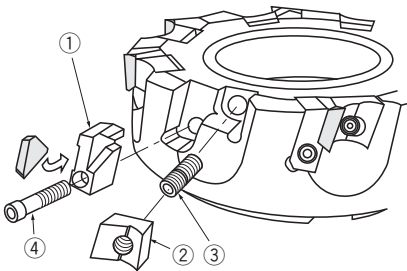

No.	Part Name	Part Cat. No.	Stock
①	Locator	LE303R	●
		LE303L	
②	Insert locking wedge	WP302R	●
		WP302L	
③	Wedge fixing screw	DS-8	●
④	Locator fixing screw	CM4×0.7×12	●
-	T-handle wrench	TP-4	●

Note : For TSE3003R/L-3006R/L

TSE4000

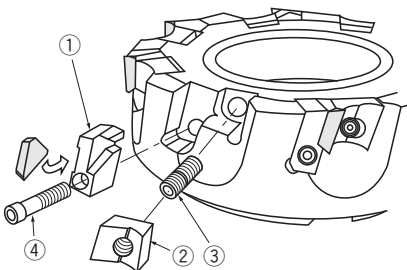

No.	Part Name	Part Cat. No.			
		For TGD4403R/L	Stock	For TGD4404R/L-4412R/L	Stock
①	Locator	LE403R	●	LE405R	●
		LE403L		LE405L	
②	Insert locking wedge	WP853TR	●	WP855TR	●
③	Wedge fixing screw	DS-8	●	DS-8	●
④	Locator fixing screw	CM4×0.7×14	●	CM4×0.7×14	●
-	T-handle wrench	TP-4	●	TP-4	●

T/ESN4000

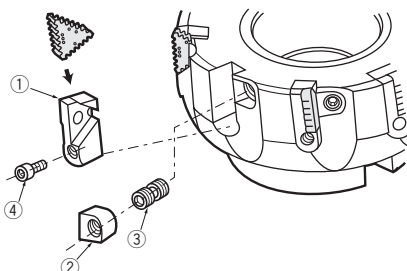

No.	Part Name	Part Cat. No.	Stock	
			R	L
①	Locator	LN403R	●	-
②	Insert locking wedge	WT402R/L	●	-
③	Wedge fixing screw	DS-8	●	
④	Locator fixing screw	SHCM4-10	●	
-	T-handle wrench	TP-4	●	

● : Stocked items.

Replacement Parts for Former PS Series TAC Mills

TFD4400

For General Inserts

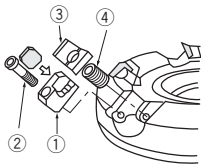

For Finishing Inserts

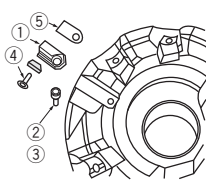

For General Inserts

No.	Part Name	Part Cat. No.	Stock
①	Locator	LD443R	●
		LD443L	
②	Locator fixing screw	Hex. socket head screw CM4×0.7×14	●
③	Insert locking wedge	WP194TR	●
		WP194TL	●
④	Wedge fixing screw	DS-8	●
-	T-handle wrench	TP-4	●

For Finishing Inserts

No.	Part Name	Part Cat. No.	Stock
①	Locator	LW444R	●
②	Locator fixing screw	Hex. socket head screw CM5×0.8×16	
③	Spring washer	5 (Nominal size)	
④	Insert locking wedge	CSTA-5S	●
⑤	Shim	SLW1.5	
-	Wrench	T-15D	●
-	Protector	PF-43	●

TFP4000 I

For General Inserts

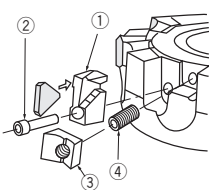

For Finishing Inserts

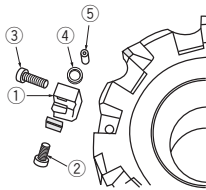

For General Inserts

No.	Part Name	Part Cat. No.			
		For TFP4004R/LI	Stock	For TFP4005R/LI-4012R/LI	Stock
①	Locator	LP403R	●	LP405R	●
		LP403L		LP405L	
②	Locator fixing screw	CM4×0.7×14	●	CM4×0.7×14	●
③	Insert locking wedge	WP153T	●	WP155T	●
④	Wedge fixing screw	DS-8	●	DS-8	●
-	T-handle wrench	TP-4	●	TP-4	●

For Finishing Inserts

No.	Part Name	Part Cat. No.	Stock
①	Locator	LW404R	●
		LW404L	
②	Clamping screw	CSTA-5S	●
③	Locator fixing screw	Hex. socket head screw CM5×0.8×16	
④	Nut	SRW11	
⑤	Adjusting wedge fixing screw	DS-6	●
-	Spring washer	5 (Nominal size)	
-	Wrench	T-15D	●
-	Protector	PF-43	●

Note: Inserts are compatible with LS-series TAC Mills.

VSN6000 I

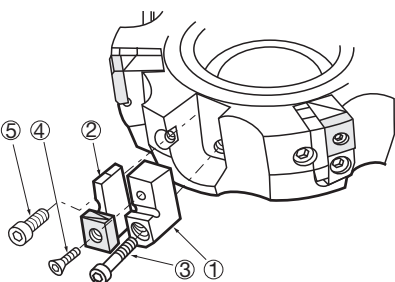

No.	Part Name	Part Cat. No.	Stock
①	Locator	LV556R/L	
②	Insert locking wedge	WV556R/L	
③	Locator fixing screw	CM6×1.0×25	
④	Insert fixing screw	CSTA-5	●
⑤	Wedge fixing screw	CM6×1.0×10	
-	T-handle wrench	T-15D	●

● : Stocked items.

Replacement Parts for Former TAC Mills

■ TMD4100 I

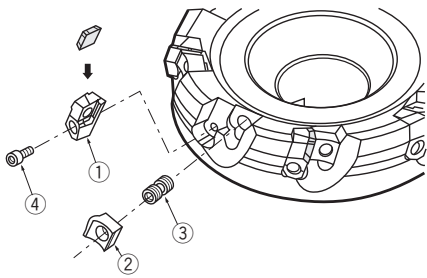

No.	Part Name	Part Cat. No.	Stock
①	Locator	LD413R	●
		LD413L	
②	Insert locking wedge	WP440R	●
		WP440L	●
③	Wedge fixing screw	FDS-8S	●
④	Locator fixing screw	CM4×0.7×12	
-	T-handle wrench	TP-4	●

■ TPN6400 I

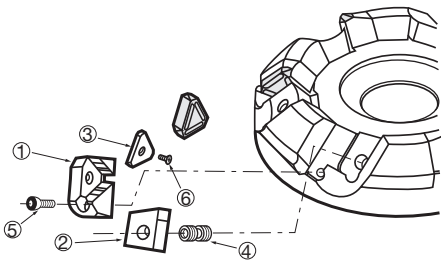

No.	Part Name	Part Cat. No.	Stock
①	Locator	LN645R/L	
②	Insert locking wedge	WN645R/L	
③	Shim	STN62R/L	
④	Wedge fixing screw	DS-10	●
⑤	Locator fixing screw	CM5×0.8×18	
⑥	Shim screw	SM3×0.5×8	●
-	Spring washer	5(Nominal size)	
-	T-handle wrench	TP-5	●

■ TPN14

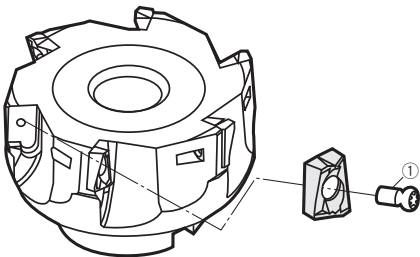

No.	Part Name	Part Cat. No.	Stock
①	Insert fixing screw	CSTB-3	●
-	Wrench	T-9D	●

■ T/EAD12

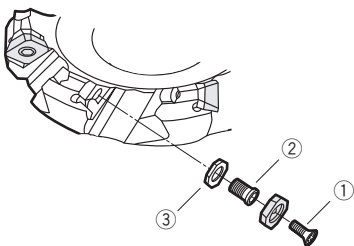

No.	Part Name	Part Cat. No.			
		TAD12050R, TAD12050RB TAD12063RI/B EAD12025R EAD12032R, EAD12040R EAD12050R/RB EAD12063RI/B	Stock	TAD12080RI/B TAD12100RI/B TAD12125RI/B EAD12080RI/B	Stock
①	Clamp screw	CSTB-3.5TS	●	CSTB-3.5T	●
②	Shim fixing screw	-		DTS5-3.5	●
③	Shim	-		FSSA42	●
④	Wrench	-		P-3.5	●
-	Wrench	T-20D	●	T-20D	●

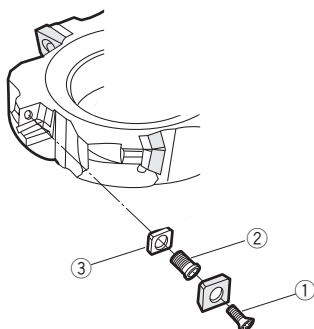

■ T/EPD12(I)(B)



No.	Part Name	Part Cat. No.			
		T/EPD12050R/RB T/EPD12063RI/B EPD12025R EPD12032R EPD12040R	Stock	T/EPD12080RI/B TPD12100RI/B TPD12125RI/B	Stock
①	Clamp screw	CSTB-3.5TS	●	CSTB-3.5T	●
②	Shim fixing screw	-		DTS5-3.5	●
③	Shim	-		FSSP42	●
④	Wrench	-		P-3.5	●
-	Wrench	T-20D	●	T-20D	●

Replacement Parts for Former TAC Endmills

■ EVP1000

Cat. No.	Clamping screw				Wrench			
								
	For end edge	Stock	For peripheral edge	Stock	For end edge	Stock	For peripheral edge	Stock
EVP1016R	CSTB-3S	●	CSTB-2.2S	●	T-9F	●	T-7F	●
EVP1020R	CSTB-4S	●	CSTB-2.5S	●	T-15D	●	T-8D	●
EVP1025R	CSTB-5S	●	CSTB-3S	●	T-20D	●	T-9D	●

■ ESD5000

No.	Part Name	Part Cat. No.	Stock
①	Clamping screw	RT-1	●
②	Clamp	CP724	●
③	Wrench	P-4	●



■ ESD2000

No.	Part Name	Part Cat. No.	Stock
①	Clamp Sets	CSW-0T	●
②	Wrench	T-15F	●

■ ERD4000

No.	Part Name	Part Cat. No.	Stock
①	Fixing screw	CSTB-4S	●
②	Clamp Sets	CSW-0T	●
③	Wrench	T-15D	●

■ EPN09/14

Cat. No.	Clamping screw		Wrench	
		Stock		Stock
EPN09010R / EPN09012R	CSTB-2.5S	●	T-8D	●
EPN09016R ~ EPN09050R	CSTB-2.5	●		●
EPN140□□R	CSTB-3	●	T-9D	●

■ TBF1000

No.	Part Name	Part Cat. No.					
		For TBF1320S	Stock	For TBF1400S	Stock	For TBF15~TBF1600S	Stock
①	Main insert clamping screw	CSTB-4	●	CSTA-4	●	CST-5S	●
②	Clamp	-		CP536	●	CP536	●
③	Clamping screw	-		DS-6	●	DS-6	●
④	Wrench for main insert	T-15D	●	T-15D	●	T-25D	●
⑤	Wrench for peripheral insert	-		P-3	●	P-3	●

Replacement Parts for Former TAC Drills

■ TDR

Cat. No.	Part Cat. No.			
	Fixing screw	Stock	Wrench	Stock
TDR-180 ~ 190	CSTB-2.2	●	T-7D	●
TDR-195 ~ 285	CSTA-NO3	●	T-9D	●
TDR-290 ~ 345	CSTA-NO5	●	T-9D	●
TDR-350 ~ 540	CSTA-4	●	T-15D	●

■ TDJ

Cat. No.	Part Cat. No.			
	Fixing screw	Stock	Wrench	Stock
TDJ-140	CSTC-2	●	T-6D	●
TDJ-145				
TDJ-150				
TDJ-155				
TDJ-160				
TDJ-165				
TDJ-170				
TDJ-175				

● : Stocked items.